

# BATTERY MONITOR 500

Item number: 90-60-517



## USER MANUAL & INSTALLATION SHEET

**nke**  
MARINE ELECTRONICS

Zi de Kerandré – Rue Gutemberg – 56700 – HENNEBONT – FRANCE

[www.nke-marine-electronics.com](http://www.nke-marine-electronics.com)



+33 297 365 685

1. Introduction.....	3
1.1 Usage .....	3
2. Operation.....	4
2.1 PEUKERT's exponent .....	4
2.2 Round-trip efficiency.....	4
3. Battery Monitor 500 setup .....	6
3.1 Setup with a MULTIGRAPHIC display.....	6
3.1.1 Set up the nominal capacity for the battery.....	6
3.1.2 Reset and adjustment of the nominal capacity.....	7
3.2 Setup with a PERFORMANCE display.....	7
3.2.1 Set up the nominal capacity .....	7
3.2.2 Adjustment of the nominal capacity .....	7
3.3 Set up with a TL25.....	8
3.3.1 Set up the nominal capacity of the battery .....	8
3.3.2 Adjustment of the nominal capacity .....	8
3.4 Setup with a Gyrographic .....	8
3.4.1 Set up the nominal capacity of the battery .....	8
3.4.2 Adjustment of the nominal capacity of the battery.....	8
3.5 Managing more than two battery banks.....	9
3.6 Setting the Adjustment .....	9
4. Installation .....	9
4.1 Wiring the Shunt.....	10
4.2 Wiring the Battery Monitor 500 .....	11
4.3 Commissioning the device.....	11
4.4 NMEA output .....	12
4.5 Alarm output.....	12
5. Battery Monitor 500 specifications.....	13
5.1 Mechanical specifications of the shunt .....	13
5.2 Mechanical specifications of the Battery Monitor 500's housing.....	14
5.3 Electrical specifications of the shunt.....	14
5.4 Battery Monitor 500 specifications.....	15

## 1. INTRODUCTION

The **Battery Monitor 500** provides information on the status of your batteries. Information includes the voltage, the charge or discharge current, used capacity (amp/h) and the capacity level of each battery in %, for battery #1 (service) and battery #2 (starter). All information is available on each display when connected to the **Topline** bus. The **Battery Monitor 500** features LED indicators that show the voltage for the 2 batteries, the charge status and charge completion of battery #1 and the alarm status. The **Battery Monitor 500** automatically detects the battery type: 12 or 24 V.

### 1.1 Usage

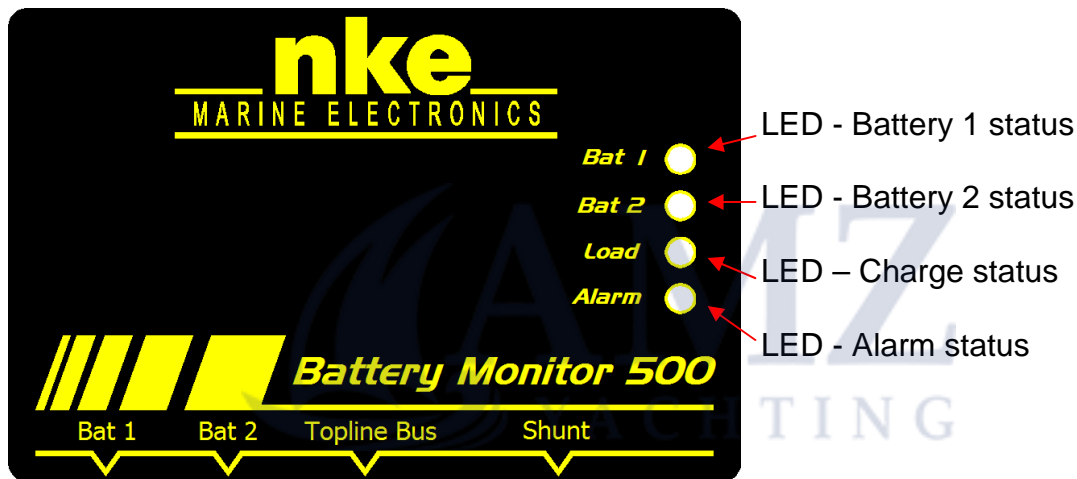

LED **Bat 1**: Indicates the measured voltage on battery #1. LED is green when the measured voltage is > 11.6 V (or 23.2 V), and red when the measured voltage is < 11.6 V (or 23.2 V). LED is off if the **Battery Monitor 500** is not connected to the battery #1

LED **Bat 2**: Indicates the measured voltage on battery #2. LED is green when the measured voltage is > 11.6 V (or 23.2 V), and red when the measured voltage is < 11.6 V (or 23.2 V). LED is off if the **Battery Monitor 500** is not connected to the battery #2.

LED **Load**: this LED blinks green when the battery #1 is being charged. The green light is fixed once the battery is charged. It is off if the battery is being discharged.

LED **Alarm**: This LED is red when the value has reached an alarm limit set on the **Battery Monitor 500** (voltage and capacity for battery #1 and voltage for battery #2). When the **Topline** bus is powered on, all LED indicators are off.

## 2. OPERATION

---

The main function of the **Battery Monitor 500** is to monitor the battery status in order to avoid unexpected deep discharge.

The Battery Monitor 500 constantly measures the current flow input and output on the battery. The amount of current over a period gives the value of Amp per hour added or drawn. These values are measured even when the **Topline** bus is powered off.

*For example: a 10 Amp discharge current during 2 hours will mean  $10 \times 2 = 20\text{Ah}$  for the battery.*

What makes it more complicated is that the effective battery capacity is related to the discharge current, and also, but less importantly, to the temperature (this parameter is not considered here).

But, that's not all: when charging the battery, a certain "amount of amps" is required, affecting the total energy that can be used from the battery afterwards. In other words: the round-trip factor is below 100%.

### 2.1 PEUKERT's exponent

Standard batteries have a nominal capacity of 20 hours. That means that a 100 Ah battery can supply 5 A during 20 hours before reaching a voltage level of 1.75 V per cell (giving 10.5 V for 12 V batteries and 21 V for 24 V one). If the discharge current is higher (i.e. 10 A), the battery will not supply the expected 100 Ah. In that case, the voltage level of 1.75 V per cell or 10.5/21.0 V will be reached before the battery has given its full capacity of 20 hours (in this example, the maximum period during which the battery can be used is approximately 8 hours, meaning 80 Ah).

The Battery Monitor 500 takes this into account and applies the PEUKERT's equation to the battery.

PEUKERT's equation's exponent can be adjusted by your installer with a value situated between 1.00 and 1.50 by using the service software "TOPLINK". The default value of that exponent is set to 1.25, which is the average value for most lead batteries. It is 1.10 for Lithium Ion batteries.

### 2.2 Round-trip efficiency

The RTE of a lead battery can be close to 100% as long as no gas is generated. Generation of gas means that some of the energy input is not stored in the battery cells, but to split water in oxygen and hydrogen (highly explosive). This means that the "Amp per hour" stored in the cells are lost in that process of splitting water.

A 95% RTE means that 10 Ah must be put in the cells to recover 9.5 Ah from the energy storage. The efficiency is linked to the battery type, its age and how it has been used. The Battery Monitor 500 considers that with an **Efficiency** set up. By default the value is set to 0.90.

The Ratio is automatically calculated and managed. Nevertheless, it can be adjusted manually under the **"Coefficient"** channel on the Multigraphic, and **"Calibration"** on other displays.

In order to ensure full level of charge as close to 100%, it is automatically adjusted if the following conditions are met:

- The battery capacity reaches 95% after a charge of at least 30%.
- The charge current reaches 2% of the nominal capacity of the battery during 3 minutes (i.e. for a 100 Ah battery the current remains above 2 Ah during 3 minutes)

When the battery becomes older, that coefficient decreases. At 0.70 (70%) the battery is considered reaching its lifespan.



### 3. BATTERY MONITOR 500 SETUP

When commissioning the device, you must set the nominal capacity in Ah for the battery bank #1. The nominal capacity is given by the manufacturer of the battery. Once the battery is fully charged, you have to set the **Battery Monitor 500** to display the correct values for capacity and battery charge level (100%) on the **Topline** bus.



If after full charge of the battery, the **Battery Monitor 500** does not indicate 100% of capacity and charge level, it should be synchronised. This is done with a reset.

#### 3.1 Setup with a MULTIGRAPHIC display

Press and hold **PAGE** to access the menu from which you can select  to display the "Sensors" page. Choose "BAT1 capacity".

##### 3.1.1 Set up the nominal capacity for the battery

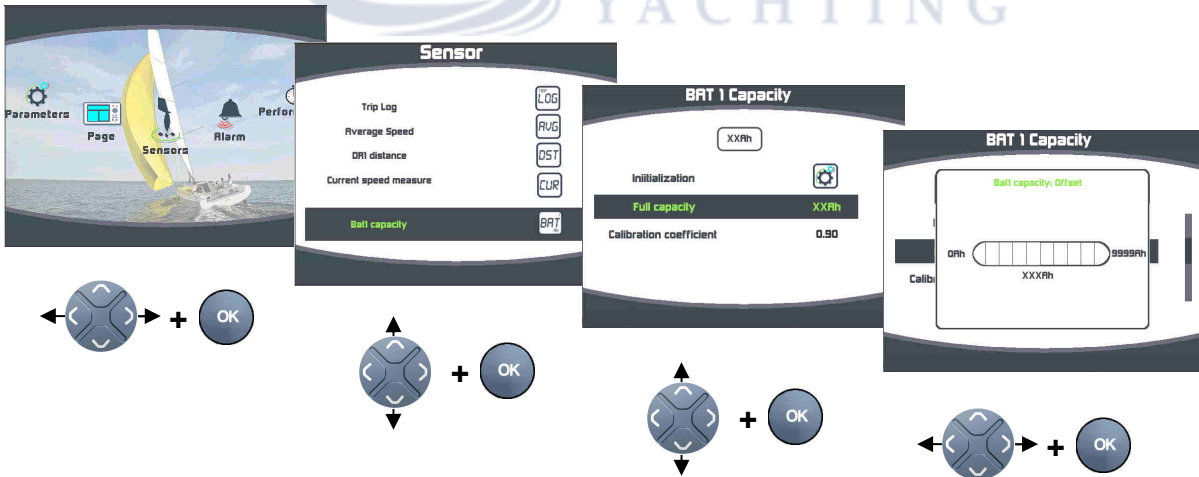

### 3.1.2 Reset and adjustment of the nominal capacity

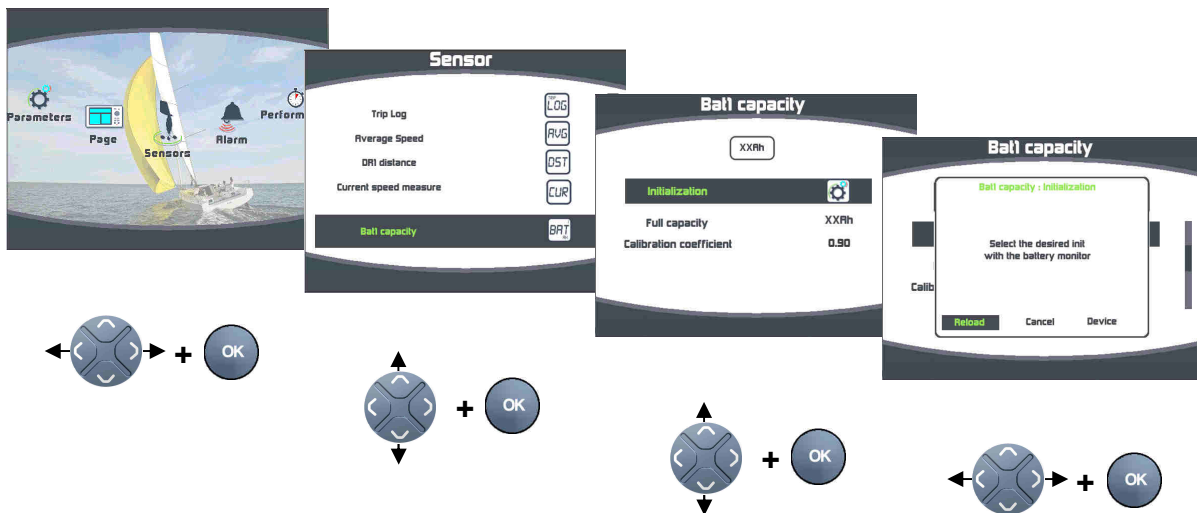

"Recalage" = adjust the nominal capacity

"Instrument" = reset of the Battery Monitor to factory default settings.

## 3.2 Setup with a PERFORMANCE display

### 3.2.1 Set up the nominal capacity

Select the channel on the top display : "Bat 1 capa".

Press and hold **Ent** until you hear a signal. "calib coeff" is displayed and alternates with "Bat 1 capa".

Release the button.

Press briefly on the button **▼** to bring "calib OFFSE" and "Bat x capa" on display.

Press briefly again **Ent** "Modif" and "calib coeff" are now displayed.

With the buttons **▲** and **▼**, adjust the value on the sub-channel "OF" to the nominal capacity of the battery in Ah (given by the manufacturer).

Example: Enter 70 for a nominal capacity of 70 Ah

Press briefly on **Esc** to come back to "Bat x capa".

### 3.2.2 Adjustment of the nominal capacity

Select the channel on the top display : "Bat x capa".

Press and hold the button until audible signal is heard.

The displayed value is adjusted at 99% of the capacity saved in the sub-channel "OF".



### 3.3 Set up with a TL25

#### 3.3.1 Set up the nominal capacity of the battery

Use a remote control (wireless or wired) to select the channel "Bat 1 capa". Press and hold  until you hear a 2nd signal (about 5 seconds). "COEFF CALIB" is displayed.

Release the button .

Press briefly on the button  to display the sub-channel "OFFSET". With the buttons ▲ and ▼, adjust the value on the sub-channel "OFFSET" to the nominal capacity of the battery in Ah (given by the manufacturer).

Example: Enter 70 for a nominal capacity of 70 Ah

Press and hold  to come back to "Bat x Capa".

#### 3.3.2 Adjustment of the nominal capacity

Select the channel on the top display : "Bat x capa"

Use the button  to select the middle display (the display blinks).

Press and hold ▼ until the value is adjusted at 99% of the capacity (in Ah) saved in the sub-channel "OFFSET".

### 3.4 Setup with a Gyrographic

#### 3.4.1 Set up the nominal capacity of the battery

Use the button **Page** to select the page **Menu principal**,

use the pad  to select **Configuration** and then **calibration**, press **Ent**,

in the channels list, select **Capacité Bat 1** and press **Ent**,

select **Offset** and press **Ent**

Use the pad  to place the cursor on the correct value for the nominal capacity, confirm your choice by pressing **Ent** or exit by pressing **Page**.

#### 3.4.2 Adjustment of the nominal capacity of the battery

Use the button **Page** to select the page **Menu principal**,

use the pad  to select **Configuration** and then **calibration**, press **Ent**,

in the channels list, select **Capacité Bat 1** and press **Ent**,



select **Init** and press **Ent**

select "**OUI**" with the pad ,

confirm your choice by pressing **Ent** or exit by pressing **Page**.

### 3.5 Managing more than two battery banks

Several **Battery Monitor 500** can be connected to the same **Topline** bus to monitor several battery banks (BAT1, BAT2, BAT3, BAT4).

Contact your dealer for several **Battery Monitor 500** configuration and settings.

### 3.6 Setting the Adjustment

This parameter is used for automatic adjustment of the Battery Monitor. When the charge current drops below the value set with this parameter (percentage of the battery capacity), the battery is considered as fully charged.

By default it is set at 2%, which means that for a 100 Ah battery, it will be considered as fully charged when the charging current reaches 2 Ah.

This parameter can be set between 2% and 5% with the Toplink service software.

## 4. INSTALLATION

---



### WARNING

Shut off the circuit before doing any maintenance. This can be done by removing the fuses or disconnect the batteries. Turn off all charger systems.

## 4.1 Wiring the Shunt

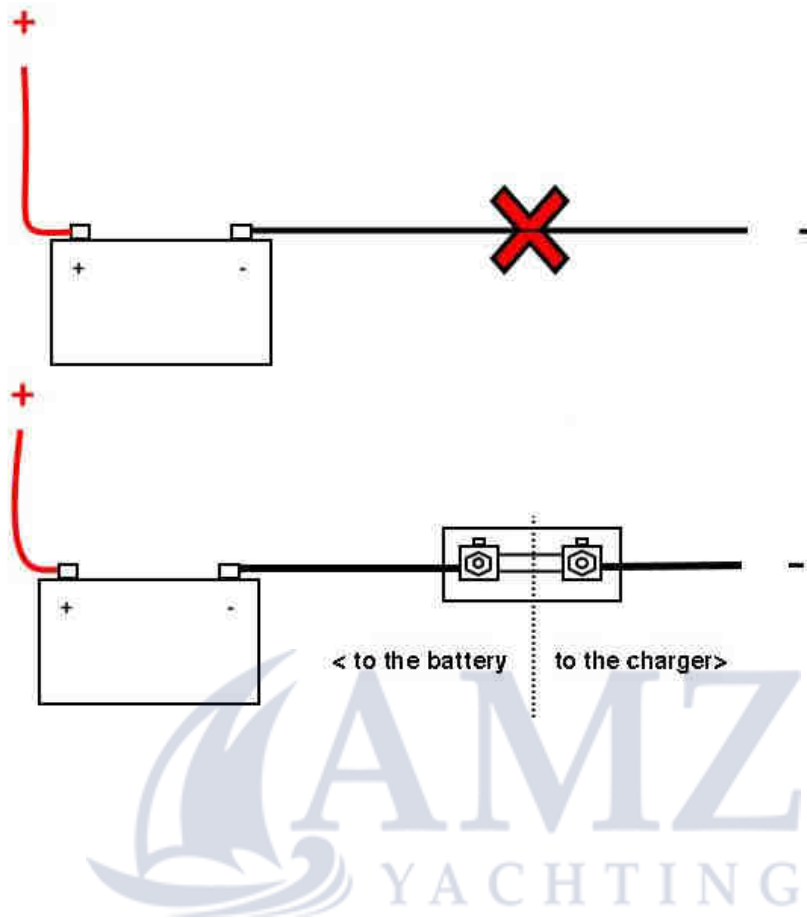

- Disconnect the negative cable from the battery
- The shunt is wired on the negative line between the battery and the charger.



### WARNING

Only the cable connecting the shunt to the battery is to be connected to the negative terminal of the battery. Should there be other cables connected to the negative terminal of the battery before installing the shunt, these will be now connected to the shunt.

## 4.2 Wiring the Battery Monitor 500

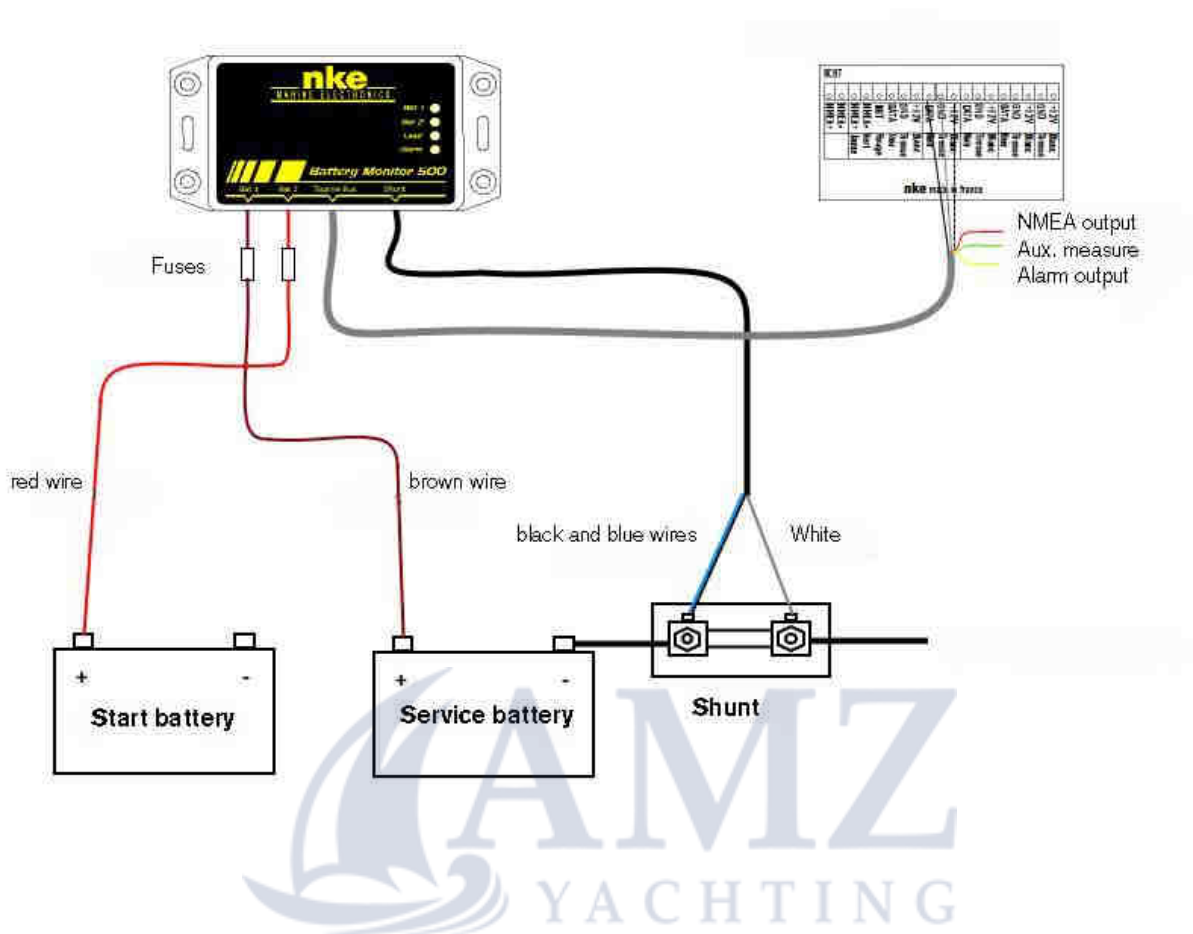

- Connect the brown wire "bat1" to the service battery positive (+) terminal.
- Connect the brown wire "bat2" to the starter battery positive (+) terminal.
- Connect the shunt cable as follow:
  - The blue and black wires to the shunt, on the battery side
  - The white wire to the shunt on the electric panel side
- Connect the bus cable to a Topline junction box as follow:
  - White wire to the "+12 volts" terminal
  - Shield to the "GND" terminal
  - Black to the "Data" terminal

## 4.3 Commissioning the device

Commissioning the Battery Monitor 500 is done by powering on the Topline bus and setting and adjusting the capacity of the service battery (refer to r §3 )

#### 4.4 NMEA output

2 proprietary NMEA0183 sentences are available on the Topline red wire:

Battery 1

\$PNKEP,11,xx.x,x.xx,xx.x,xx.x\*hh

| | | | \_battery level %

| | | \_used capacity

| | \_current

| \_voltage

Battery 2

\$PNKEP,12,xx.x,,,\*hh

| \_voltage

#### 4.5 Alarm output

An alarm output of open-collector type is available on the red wire to relay the Battery Monitor 500 alarm.

Connect as follow:

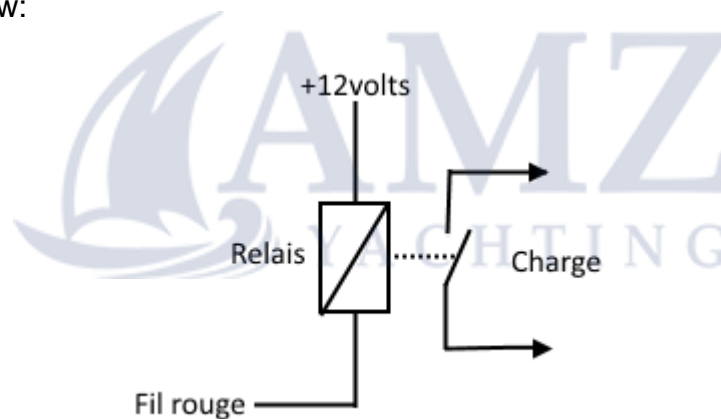

## 5. BATTERY MONITOR 500 SPECIFICATIONS

---

### 5.1 Mechanical specifications of the shunt

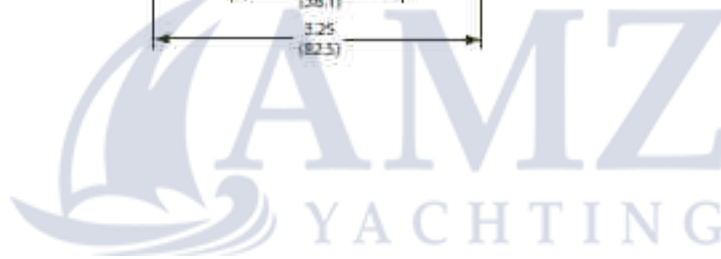
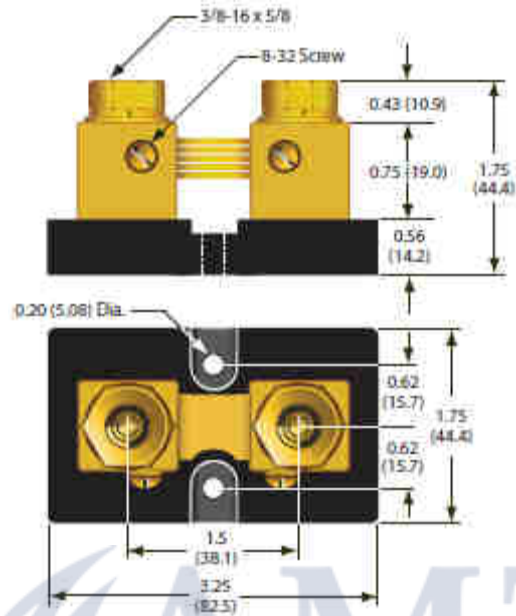

## 5.2 Mechanical specifications of the Battery Monitor 500's housing

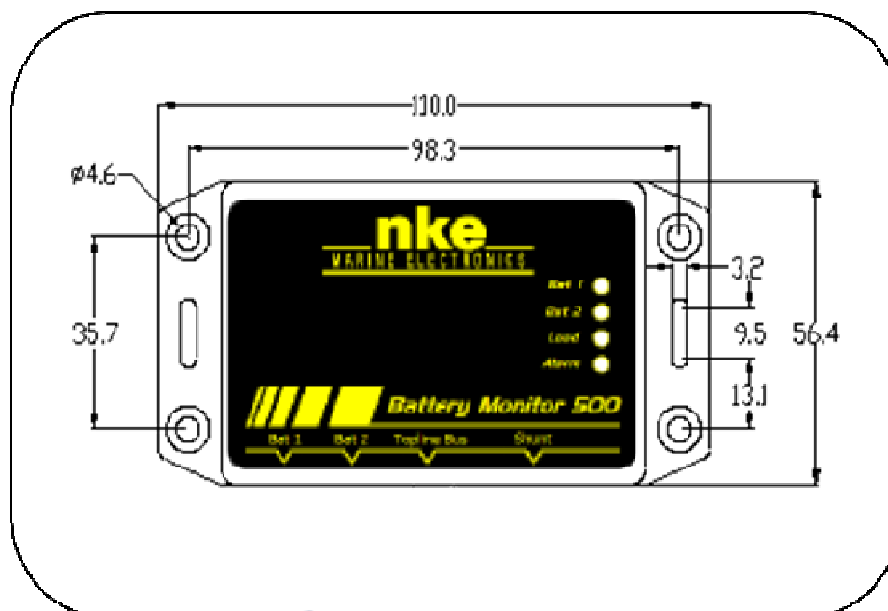

## 5.3 Electrical specifications of the shunt

Description	Value
Input current range	-500A to +500A
Resistance @ 25°	0.0001 $\Omega$
Accuracy	$\pm 0.25\%$
Operational temperature	-40° to +60°
Weight	250 gr

#### 5.4 Battery Monitor 500 specifications

Description	Value
Power supply	8V – 32V DC
Measure range for battery voltage	10 V to 30 V
Accuracy of voltage measure	±0.06volt
NMEA output	NMEA0183 proprietary sentences
Weight	300 gr
Operational consumption @ 12 V	< 20mA
Consumption with Topline bus switched off	< 5mA
Topline bus power cable	Ø5.5mm, 4 wires + ground, length 6m
Cable for battery voltage measure (red and brown)	3m – 0.6mm <sup>2</sup>
Cable for shunt	1 m of 2 x 0,22mm <sup>2</sup> twisted

